

REV	DATE	NOTE
1	2018.04.	

벽지지대 (Min.700mm ~ Max.1300mm)

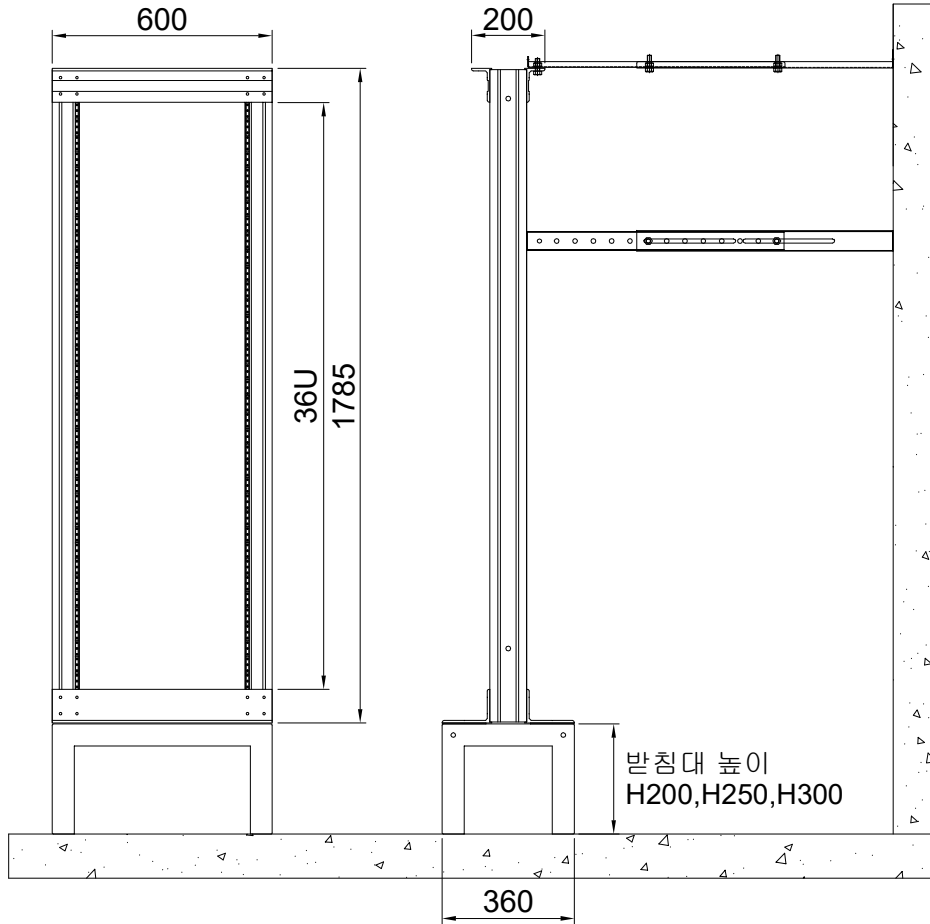

FRONT VIEW

SIDE VIEW

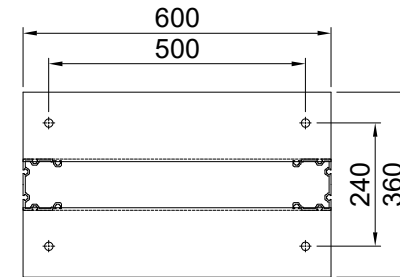
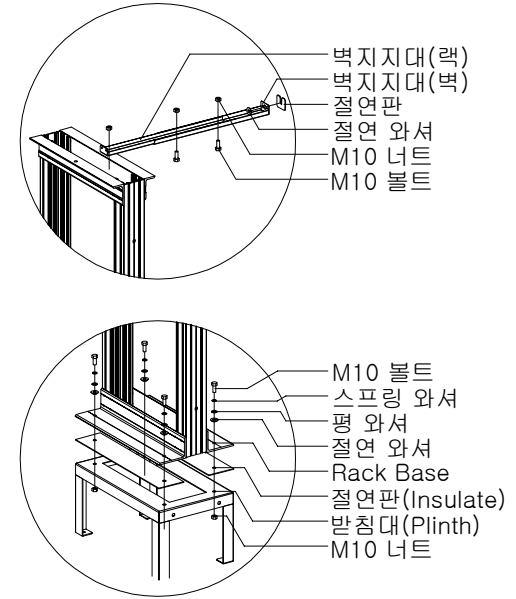

BASE VIEW

DESIGNED	CHECKED	APPROVED	모델명	OPR360-36A	
SON	-	HP	규격	H1800xD360xW600(19")	
			UNIT	mm	PROJECTION
			SCALE	1/1	

REV	DATE	NOTE
1	2018.04.	

벽지지대 (Min.700mm ~ Max.1300mm)

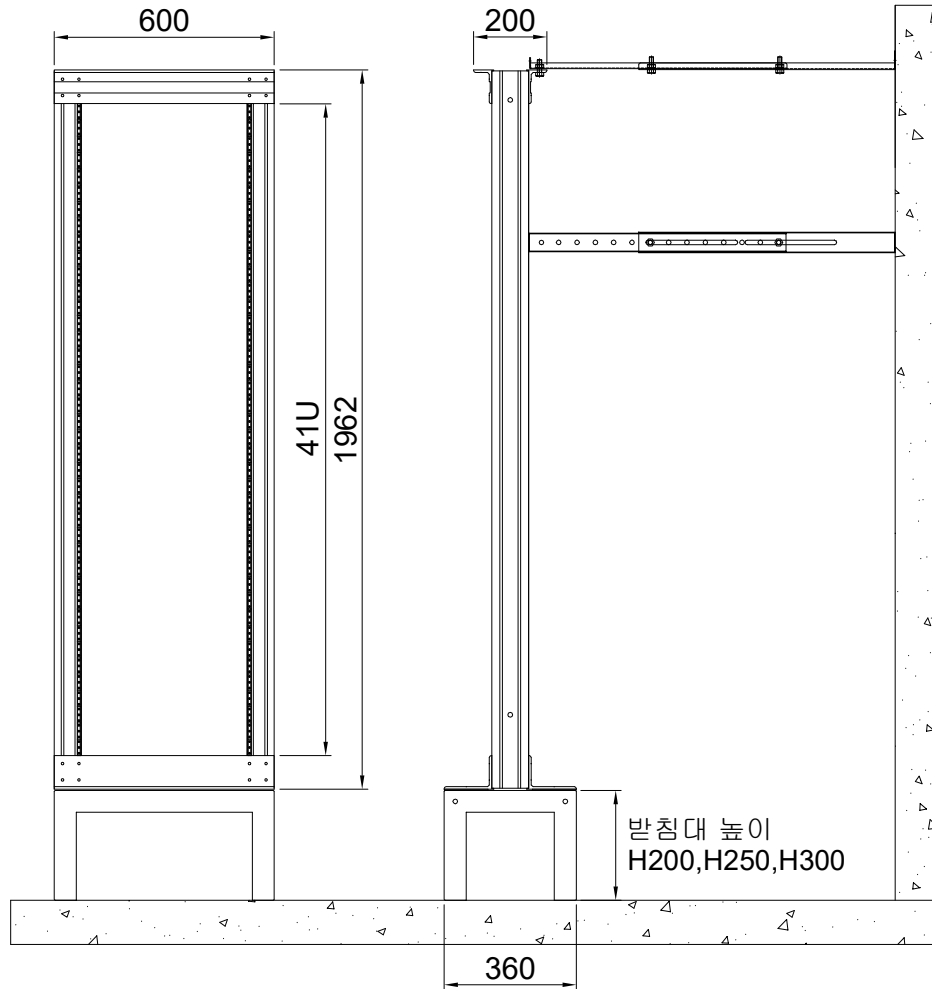

FRONT VIEW

SIDE VIEW

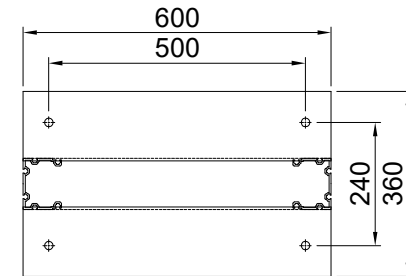
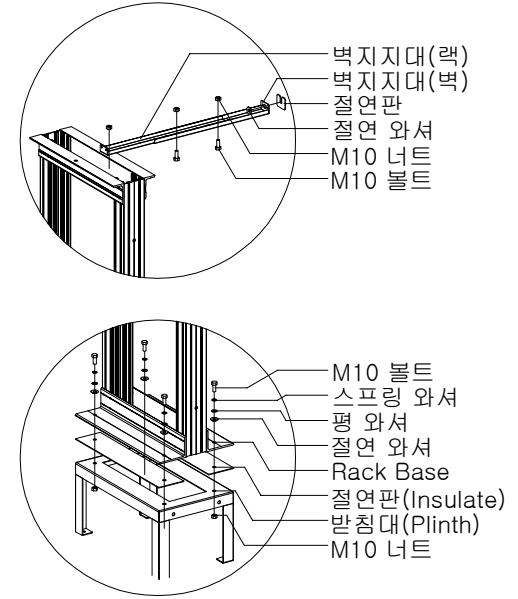

BASE VIEW

DESIGNED	CHECKED	APPROVED	모델명	OPR360-41A	
SON	-	HP	규격	H2000xD360xW600(19")	
			UNIT	mm	PROJECTION
			SCALE	1/1	

REV	DATE	NOTE
1	2018.04.	

벽지지대(Min.700mm ~ Max.1300mm)

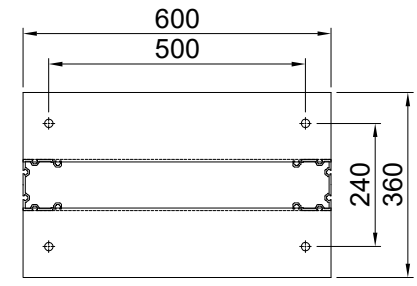
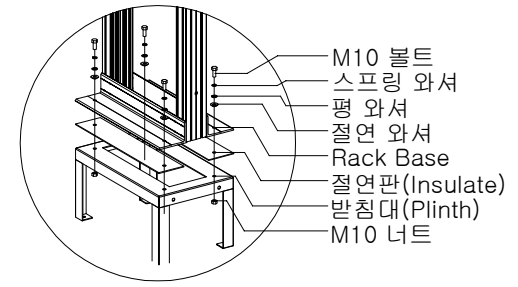
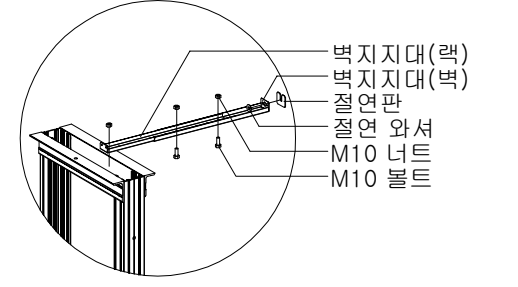
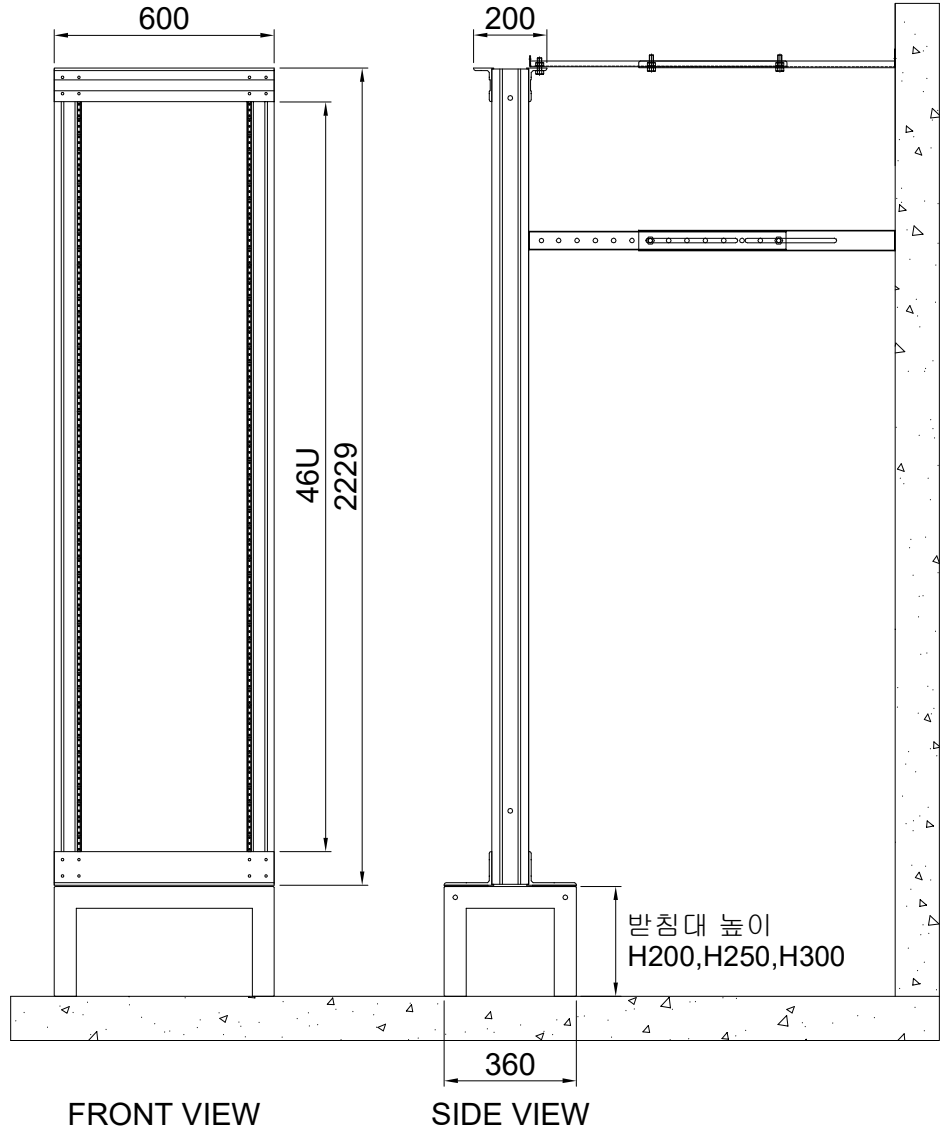

BASE VIEW

DESIGNED	CHECKED	APPROVED	모델명	OPR360-46A	
SON	-	HP	규격	H2200xD360xW600(19")	
			UNIT	mm	PROJECTION
			SCALE	1/1	SHEET NO
					1/1

REV	DATE	NOTE
1	2018.04.	

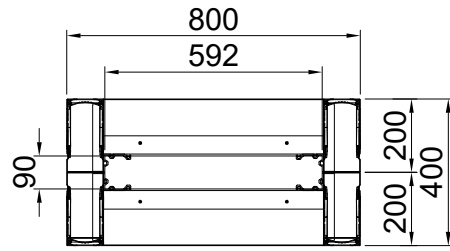

TOP VIEW

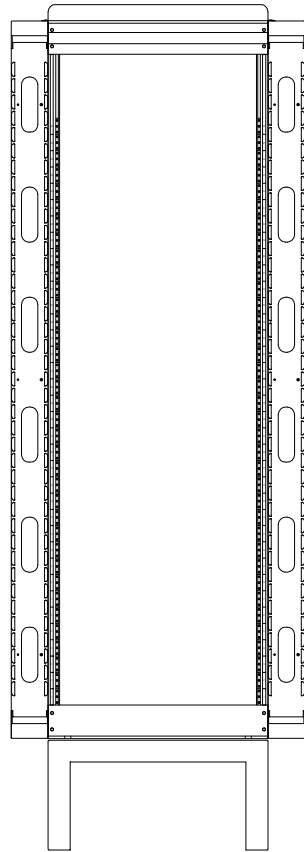

FRONT VIEW
(Vertical Door Removed)

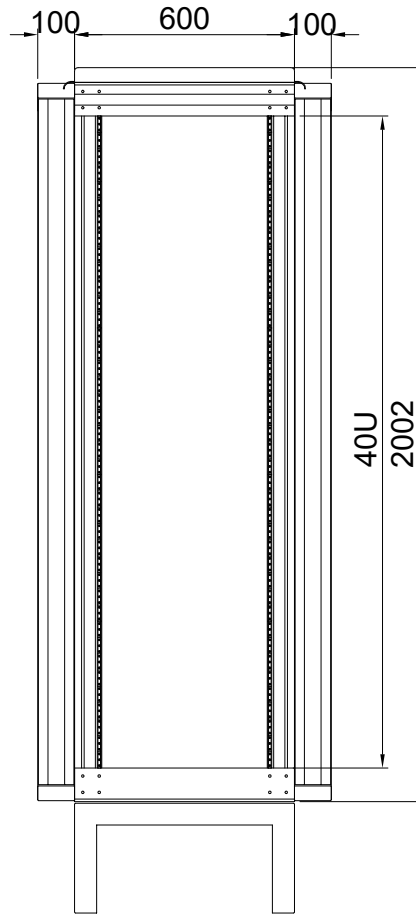

FRONT VIEW

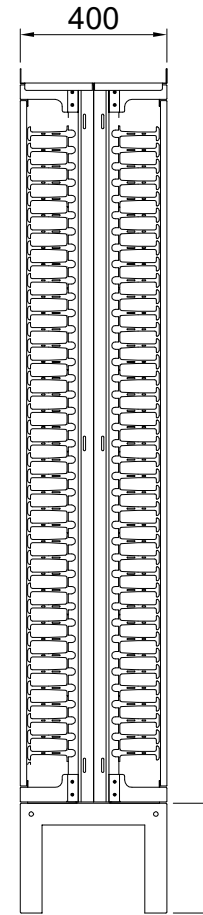

SIDE VIEW

DESIGNED	CHECKED	APPROVED	모델명	OP 패치랙(오픈)	
SON	-	HP	규격	H2000xD400xW600(19")	
			UNIT	mm	PROJECTION
			SCALE	1/1	